



# ENTRA AUTOMATIC WHEEL WASHER (Wheel Wash System)



*Best quality,  
Customer's confidence,  
Fulfilling promise*

**entra**

**HEADQUARTERS FACTORY**

28-9, Gilcheonsaneop 3-gil, Sangbuk-myeon, Ulju-gun, Ulsan, Korea  
Tel. +82-52-254-1934 Fax. +82-52-254-1938

**HWASEONG FACTORY**

1435-27 Sucheon-ri, Jangan-myeon, Hwasung-ri, Gyeonggi-do  
Tel. +82-52-225-1934 Fax. +82-52-225-1936

# Welcome to ENTRA



ENTRA maintains a human first philosophy and high customer satisfaction. We have developed and advanced with the help of our loyal customers as we endeavored to create a mass produced Touch Free Car Wash System and Wheel Wash System.

We are responsible for every product we make with the highest quality manpower and superior quality system improvement according to ISO 9001 and ISO 14001 certifications. In addition, the entire ENTRA workforce is fully committed to customer success to become a reliable business partner.

CEO of ENTRA, Jae-hee Park



**Best quality with ENTRA's  
new product innovation,  
now the criterion of choice is changed.**

## History |

- 1995. 02 Established Dongseo Industrial and Equipment (Jinrae-myeon, Gimhae-si, Gyeongnam)
- 1997. 08 Relocated a new Ulsan factory (Joil-ri, Samdong-myeon, Ulju-gun)
- 2000. 08 Converted to a corporation – Dongseo High Tech Co., Ltd.
- 2000. 12 Established Seoul Office (Goyang-si, Gyeonggi-do)
- 2006. 09 Established Busan office (Sasang-gu, Busan)
- 2009. 09 Separated the Seoul office, and established Dos Co., Ltd.
- 2010. 02 Established Enterprise Annex Lab
- 2010. 12 Established Hwasung Plant in Gyeonggi-do
- 2011. 04 Awarded a prime minister prize
- 2012. 12 Relocated a new Ulsan factory (Industrial Complex in Gilcheon, Sangbuk-myeon, Ulju-gun)
- 2013. 12 Manufactured and installed a car wash system inside a Metropolitan landfill
- 2014. 11 Awarded a Mutual Growth Industrial Prize from President
- 2015. 08 Awarded a Filial Piety Prize
- 2016. 01 Changed the company name to ENTRA
- 2017. 01 Set up car wash system in KOREA SOUTH-EAST POWER CO.

## ENTRA Automatic Wheel Washer (Wheel Wash System) Features of ENTRA automatic wheel washer

### 1. Automatic wheel washing system

A super-high speed washing system operated by detecting the vehicle's In and Out movements by means of sensors. Balanced nozzle locations make wheel washing perfect on both the inside and outside of wheels, as well as underbody of the vehicle in an optimum time.

### 2. Strength design for durability

- |   |  |
|---|--|
| 1) All assembled parts conform to KS standards. | 2) Main frame CAD designed and built tough to last.    |
| 3) Mig (CO2) welding used.                      | 4) Special paints and sandblasting to prevent rusting. |

### 3. Self-circulating cleaning water and automatic water supply system

Submersible pump installed in the wheel washer enables cleaning water to self-circulate, and automatic water supply system ensures a constant supply of cleaning water.

### 4. Automatic sludge removal system

- 1) Powered chain conveyor installed in the wheel washer pushes out the submerged soil and debris automatically.
- 2) Rubber blade made of special material provides an excellent anti-abrasion property and thus lengthens the machine's durability.

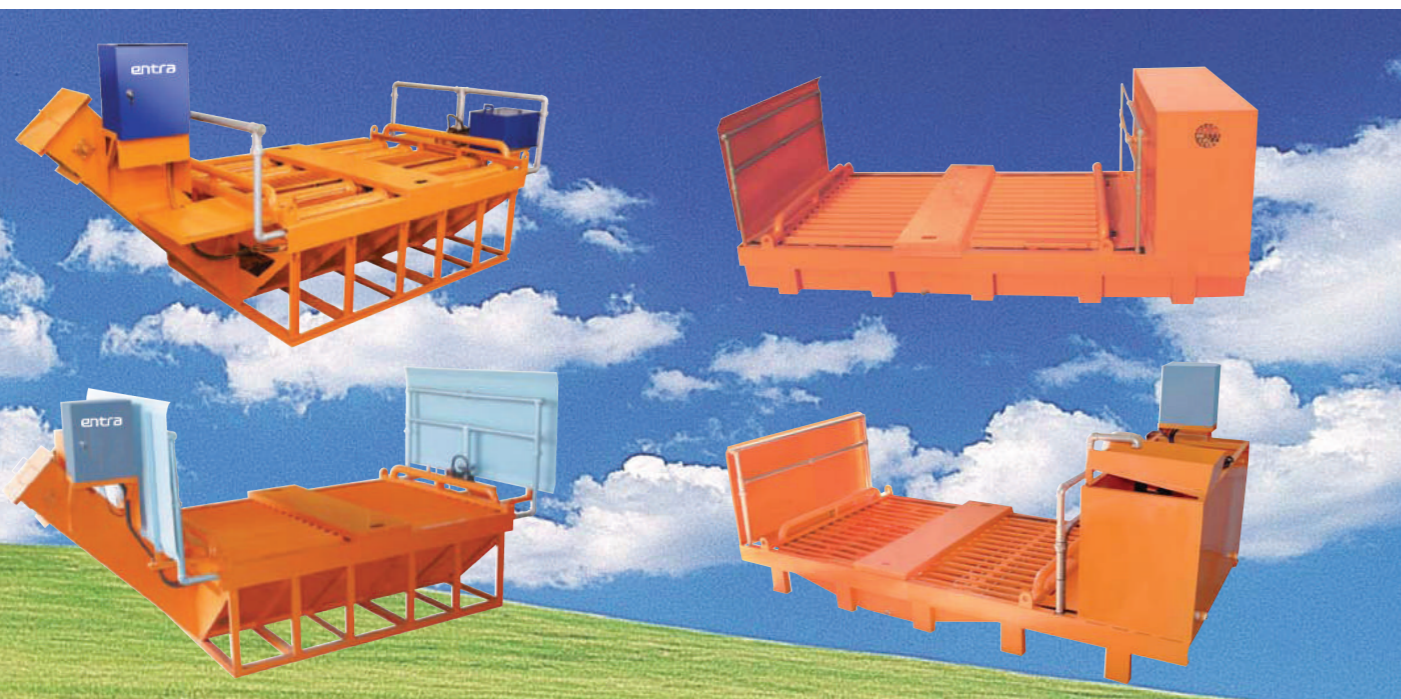

## DTW-110 ROLLER TYPE Operating System

High-quality and fully automatic ENTRA wheel washer with minimum installation space. Maximum effectiveness for wheel washing!



OPTION  
Steel Pit

DTW  
- 110

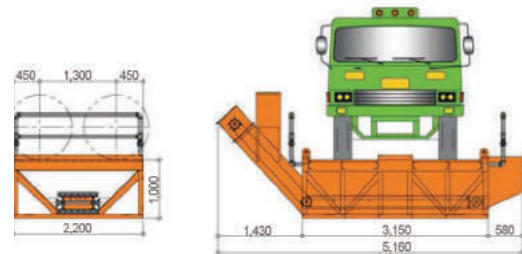

### SPECIFICATION

Item	Description
Model name	DTW-110
Machine standard	2200mm(w) x 5160mm(L) x 1000mm(H)
Machine weight	4,700kg
Available vehicle (max. axle load)	25Ton, Heavy-duty dump truck (15tons)
Washing time	45sec
Capability	Max640 Trucks/day (8hours)
Power supply	220/380V, 3phase, 50Hz (Changeable)
Power consumption	15.5kW
Operating method	Automatic operation c/w limit switch sensor
Working pressure	3-4kgf/cm <sup>2</sup> (43-56 psi)

The specifications above are subject to change without notice for quality improvement.

## Wheel washing procedure



### Driving vehicle IN

Drive the vehicle IN according to the guides as slowly as possible and locate the front wheels in the middle of two forward rollers.

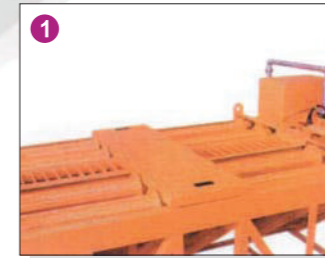

### Durability

The roller is made of durable steel pipes. Round bars are welded on to the ROLLER to prevent the slipping of the wheel during operation. Furthermore, it can remove the mud between wheels when the ROLLER revolves.



### Washing of front wheels and frontal underside of the vehicle

Put the manual gear on neutral position and release all breaking systems. The machine will start washing the inside and outside of the wheels and underside of the vehicle.



### Vehicle sensing device with LIMIT SWITCH

The limit switch installed between the rollers senses the vehicle. The machine has a timer for adjusting the washing time.



### Washing of rear wheels and rear underside of the vehicle

Drive forward slowly and locate the rear wheels in the middle of the two forward rollers. Put the manual gear on the neutral position and release all breaking systems. The machine will start washing the rear wheels and the rear body at the underside of the vehicle.

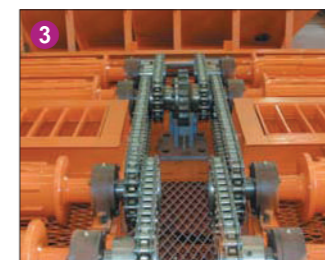

### Protection device for backlash

This device has a RATCHET system to protect backlash. It protects cutting on to the roller, chain and protects the gear box.



### Driving away

After completion of washing the rear wheels, drive the vehicle away slowly.



### Automatic sludge removal device

This device, complete with a scraper conveyor chain and sludge guide chute operates automatically to remove solids from the wash unit helping to keep construction site clean.



### Automatic sludge removal

After 1 cycle, the machine will remove the sludge and start refilling water automatically to prepare for the next cycle.



### Collected solids

- > Easy and safe disposal.
- > Construction site remains clean
- > Environment protected.

## DTW-241 GRATING TYPE Operating System

High-quality and fully automatic ENTRA wheel washer with minimum installation space. Maximum effectiveness for washing wheel!

# ENTRA Automatic wheel washer (Wheel Wash System)

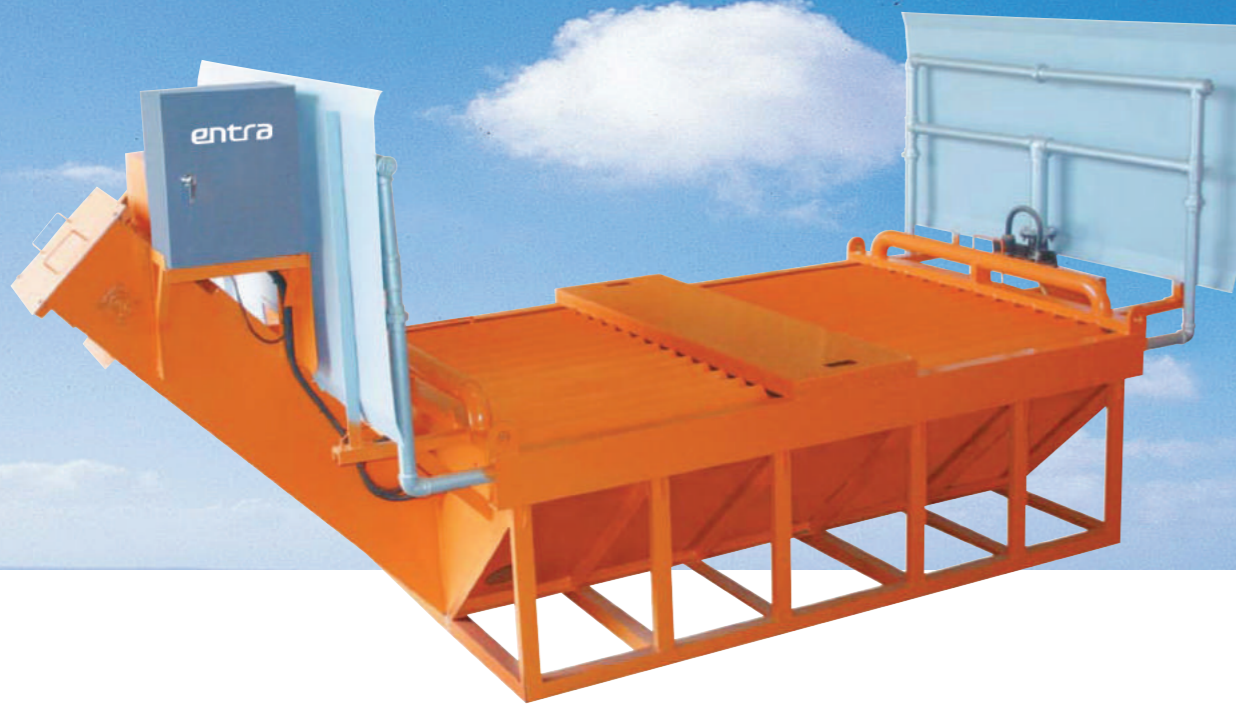

### Features of Grating Type wheel washer

#### 1. RAPID WHEEL WASHING / CONVENIENT MANAGEMENT



Wheel washing starts rapidly with an automatic sensor when the vehicle passes the wheel washer slowly, so there is no need for an operator. This wheel wash system is extremely efficient.

#### 2. SUITABLE FOR ALL VEHICLE TYPES



ENTRA GRATING wheel washer can wash perfectly from small trucks to heavy-duty trucks with its powerful water jets and balanced nozzle installation. Options for large sized vehicles are available. (see : EX series page 13.)

#### 3. MINIMUM SPACE REQUIRED



ENTRA Grating wheel washer can be installed at entrance or exit point to roadway. If the construction is on a slope, you can install the ENTRA GRATING wheel washer on a horizontal space with a minimum length of 6m.

#### 4. EXCELLENT DURABILITY AND EASY INSPECTION



Made from high quality components for exceptional durability and minimal downtime. By removing the safety scaffold at the center, it is easy to inspect the machine.

#### 5. EASY MAINTENANCE

Regular machine maintenance is simple and requires minimal tools, time or skill. Long life of machine and low repair cost are due to its quality components and special heat treated steel chain for the scraper conveyor.



OPTION  
Steel Pit



### SPECIFICATION

Item	Description
Model name	DTW-241
Machine standard	2200mm(w) x 5160mm(L) x 1000mm(H)
Machine weight	4,000kg
Available vehicle (max. axle load)	25Ton, Heavy-duty dump truck (15tons)
Washing time	20~40sec
Capability	Max1400 Trucks/day (8hours)
Power supply	220/380V, 3phase, 50Hz (Changeable)
Power consumption	11.75kW
Operating method	Automatic operation c/w limit switch sensor
Working pressure	3-4kgf/cm <sup>2</sup> (43-56 psi)

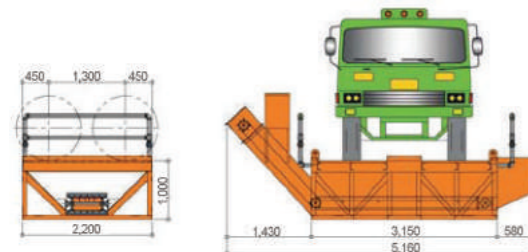

The specifications above are subject to change without notice for quality improvement.

## DTW-310 NO PIT TYPE Operating System

Washing both inside and outside of the wheels, as well as underbody of vehicle in optimal time.



OPTION Ramp set

**DTW - 310**

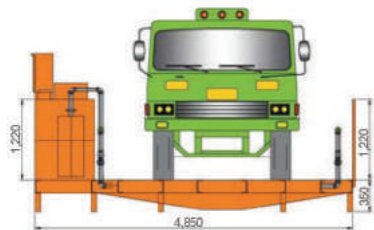

### SPECIFICATION

Item	Description
Model name	DTW-310
Machine standard	2200mm(w) x 4850mm(L) x 350mm(H)
Machine weight	3,000kg
Available vehicle (max. axle load)	25Ton, Heavy-duty dump truck (15tons)
Washing time	20~40sec
Capability	Max720~1400 Trucks/day (8hours)
Power supply	220/380V, 3phase, 50Hz (Changeable)
Power consumption	11.75kW
Operating method	Automatic operation c/w limit switch sensor
Working pressure	3-4kgf/cm <sup>2</sup> (43-56 psi)

\*It is easy to move.  
\*It is easy to clean if you lift the center safety scaffold.  
\*You don't have to install additional structure.

The specifications above are subject to change without notice for quality improvement.

## DTW-312 NO PIT TYPE Operating System

Washing both inside and outside of the wheels, as well as underbody of vehicle in optimal time.



OPTION Ramp set

**DTW - 312**

“Optional self powered by onboard Gasoline Engine.”

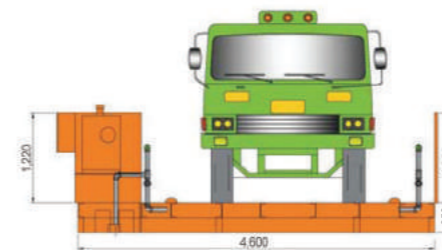

### SPECIFICATION

Item	Description
Model name	DTW-312
Machine standard	2200mm(w) x 4600mm(L) x 350mm(H)
Machine weight	3,000kg
Available vehicle (max. axle load)	25Ton, Heavy-duty dump truck (15tons)
Washing time	20~40sec
Capability	Max720~1400 Trucks/day (8hours)
Power supply	220/380V, 3phase, 50Hz (Changeable)
Power consumption	3~5kW
Operating method	Automatic operation c/w limit switch sensor
Working pressure	3-4kgf/cm <sup>2</sup> (43-56 psi)
Fuel	Gasoline
Water storage	4,000litres

\*Construction site where it is hard to supply electricity.  
\*Roadwork, embankment construction site, railway construction site.

The specifications above are subject to change without notice for quality improvement.

# DTW-310D DOUBLE TYPE Operating System

Washing both inside and outside of the wheels, as well as underbody of vehicle in optimal time.

# SPECIAL ORDER



### BOTTOM SLOPE

Sludge is perfectly discharged out of the system by natural water flow without any additional system.

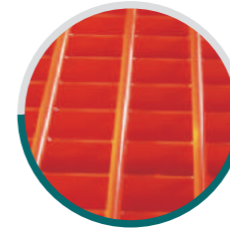

### SPECIAL GRATING BASE

Special grating base made by welded steel bars and steel plates is very durable. There is no rattling when the vehicle passes through the washing bay.

**DTW  
- 310D**

### SPECIFICATION

Item	Description
Model name	DTW-310D
Machine standard	4400mm(w) x 3710mm(L) x 450mm(H)
Machine weight	6,000kg
Available vehicle (max. axle load)	25Ton, Heavy-duty dump truck (15tons)
Washing time	20~40sec
Capability	Max720~1400 Trucks/day (8hours)
Power supply	380V, 3phase, 50Hz (Changeable)
Power consumption	15kW
Operating method	Automatic operation c/w limit switch sensor
Working pressure	3-4kgf/cm <sup>2</sup> (43-56 psi)

### FEATURE

- \*It is easy to move and install.
- \*It is simple and strong system ensures for a virtually maintenance free operation.
- \*Twice longer washing passage washes wheel and chassis effectively.
- \*The system is operated automatically by infra-red motion detecting sensor.

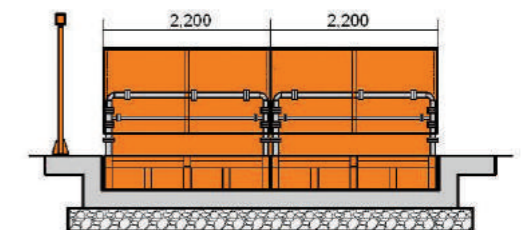
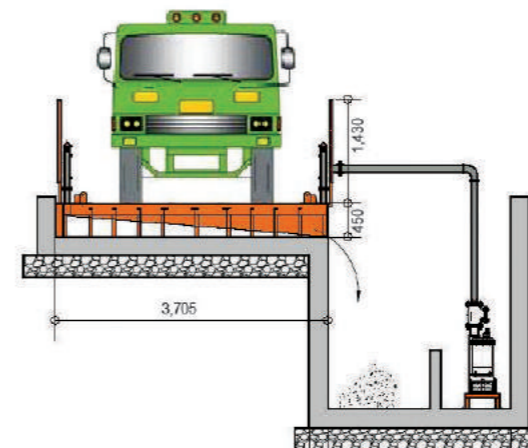

The specifications above are subject to change without notice for quality improvement.

SPECIAL ORDER

## DTW-241D6 GRATING TYPE Operating System

Washing both inside and outside of the wheels, as well as underbody of vehicle in optimal time.

## DTW-241/310 EX SERIES

In both the inside and outside of wheels, as well as underbody of the vehicle in an optimum time.



[Rearranged pipe direction]

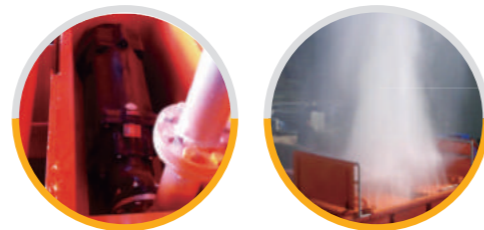

[Powerful performance with 6bar pump!]

### DTW - 241D6

#### SPECIFICATION

Item	Description
Model name	DTW-241D6
Machine standard	2200mm(w) x 5310mm(L) x 1000mm(H)
Machine weight	4,000kg
Available vehicle (max. axle load)	25Ton, Heavy-duty dump truck (15tons)
Washing time	20~40sec
Capability	Max720~1400 Trucks/day (8hours)
Power supply	220/380V, 3phase, 50Hz (Changeable)
Power consumption	23.25kW
Operating method	Automatic operation c/w limit switch sensor
Working pressure	5-6kgf/cm <sup>2</sup> (71-85 psi)

#### FEATURE

- \*Rapid and effective wheel washing system.
- \*All types of vehicles can be served.
- \*Minimum space required.
- \*Excellent durability and easy inspection.
- \*Easy maintenance.
- \*Powerful water jet.

The specifications above are subject to change without notice for quality improvement.

### EX SERIES

#### FEATURE

- \*Reinforced structure for extra vehicles.
- \*Optional sizes for over-sized vehicle and site condition.

#### SPECIFICATION

Model	Size a	Size b
DTW-241	3,150mm	5,160mm
DTW-241 EX1	4,200mm	6,260mm
DTW-241 EX2	4,700mm	6,760mm
DTW-310	3,150mm	4,850mm
DTW-310 EX1	4,200mm	5,900mm
DTW-310 EX2	4,700mm	6,400mm

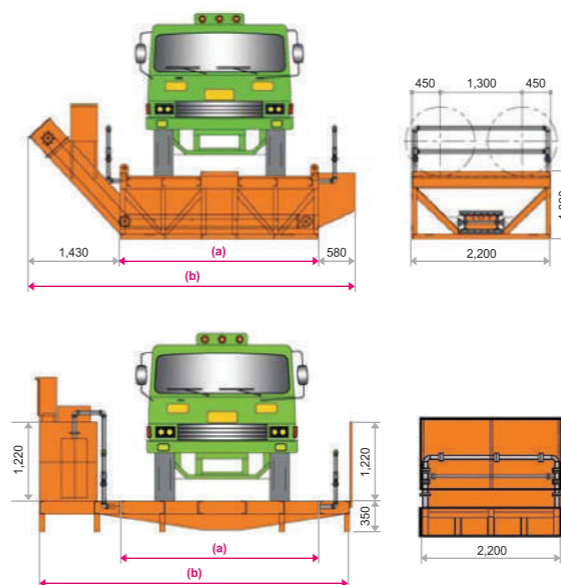

The specifications above are subject to change without notice for quality improvement.

SPECIAL ORDER

# ENTRA Wheel Washer Basis Drawing

This foundation drawing is only for **DTW-110** and **DTW-241**(right passage). Please enquire our headquarters for the drawing of other models or for a left passage wheel washer.

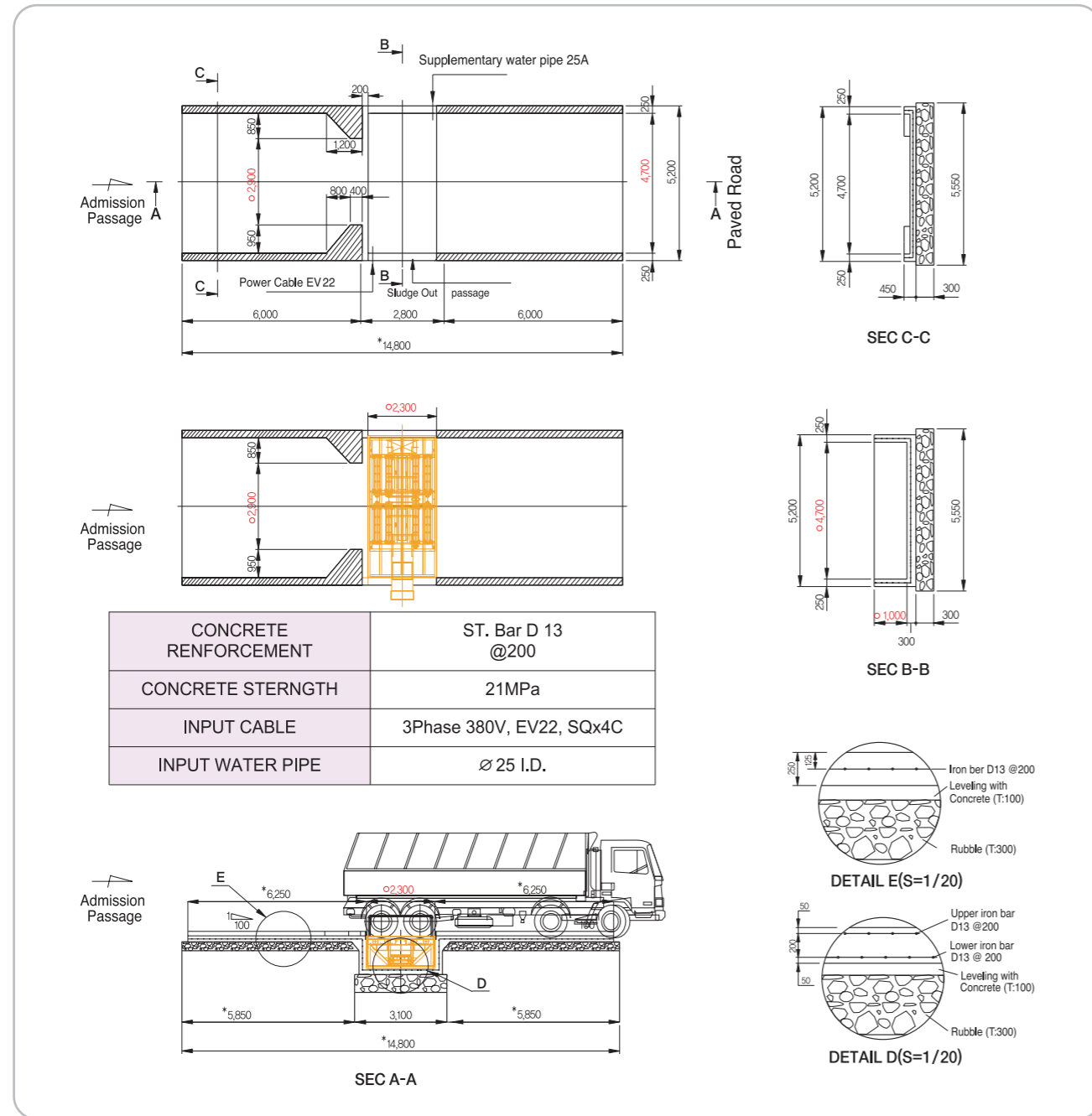

## Installation method for PIT (with concrete)

No.	Procedure of installation	Standard	Remark
1	Check the construction site	-	Check entrance, Exit, Direction and Power sources.
2	Foundation work	W3,000 x L6,000 x H1,400+( )	-
3	Fill the rubble	W3,000 x L6,000 x ( )	Decide it in accordance with the site dimensions.
4	Bottom iron bar, Concrete	W3,000 x L6,000 x H300	Having poured the concrete, it should be H1,100 from the ground surface. Check Correct Level!
5	Wall iron bar, Concrete	Proceed tetrahedral wall	Ensure joints between wall and pit floor are waterproof.
6	Pavement of the entrance and exit	W6,000 x L5,200 x H250	Check the downward slope. (1°~5°)
7	Make the vehicle guide	W6,000 x L250 x H250	-

## Drawing of PIT

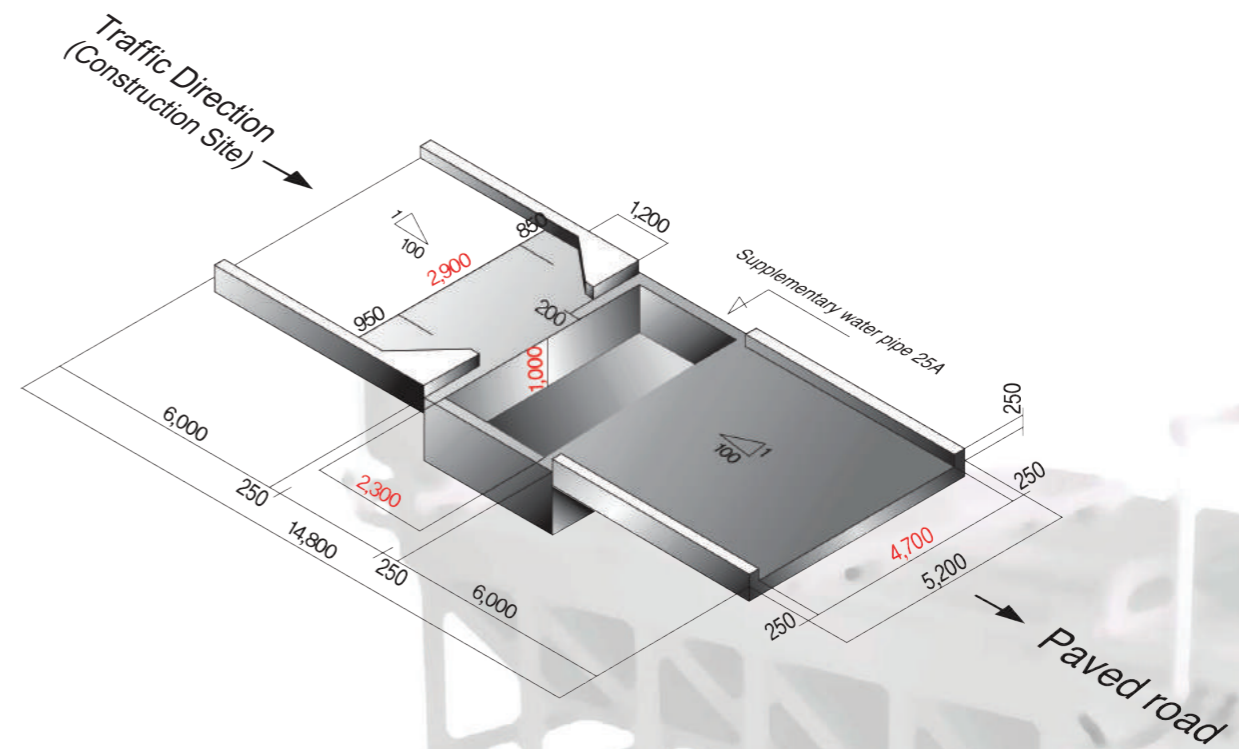

- NOTE**
1. Power cable and pipe for water can be adjusted.
  2. "\*" mark dimension that can be adjusted depending on the construction site.
  3. Measurement with this mark "O" is very important. Please check carefully.
  4. If the gap between the bottom of the machine and the ground is more than 10mm, you should reinstall the machine.
  5. Entrance and exit should be at a downward slope of 1-3%.